

**MC-4210-H2S  
ADDRESSABLE SENSOR**

**Manual Part Number 180-0458**

**December 12, 1997**

**PRODUCTION THROUGH TECHNOLOGY**

**AMR.**

*AMERICAN MINE RESEARCH, INC.*  
**P.O. BOX 234, ROCKY GAP, VA 24366  
PH. 540-928-1712 FAX 540-928-1814**

# TABLE OF CONTENTS

TITLE	PAGE
Table of Contents .....	2
List Of Figures .....	4
1. Introduction.....	5
1.0. General.....	5
1.1. Features .....	5
1.2. Default Values.....	6
1.3. New Features.....	6
2. Specifications .....	7
3. Setup.....	9
3.1. DS1 Setup Switch.....	9
3.2. DS2 Cell Polarity.....	10
3.3. DS3 2 Wire/4 Wire Comm .....	10
3.4. DS4 Comm Enable/Disable .....	11
3.5. DS5 2 Wire/3 Wire Cell .....	11
3.6. DS6 Sensor Mode .....	11
3.7. Address Switches .....	11
3.8. Setup Adjust.....	11
3.9. Zero Adjust.....	11
3.10. Reference Adjust.....	12
3.11. Comm Fuses .....	12
4. Configuration.....	13
4.0. General.....	13
4.1. Current Loop Mode Sensor (Stand Alone) .....	13
4.2. Voltage Mode Sensor (Stand Alone) .....	13
4.3. MC-4000 Monitor System Sensor/Remote .....	14
5. Installation.....	15
5.0. General.....	15
5.1. Power Connections .....	16
5.1.1. Power Connection (Stand Alone Voltage Mode).....	17
5.1.2. Power Connection (Current Loop Mode).....	18
5.2. Sensor Cell Connection .....	19
5.3. Warn/Alarm Output Connection.....	19
5.4. Analog Input #1 and Analog Input #2 Connections .....	19

## TABLE OF CONTENTS(CONT.)

TITLE	PAGE
5.5. Status Input #1 and Status Input #2 Connections .....	20
5.6. Control Output #1 and Control Output #2 Connections .....	20
5.7. Calibration/Test Switch Connection .....	20
5.8. 2-Wire MC-4000 Monitor System Connection .....	20
5.9. 4-Wire Monitor System Connection .....	20
5.10. Input/Output Interface PC Board.....	22
5.10.1. Remove MC-4210-H2S Terminal Block Board .....	22
5.10.2. Inby/Outby Power Connection.....	22
5.10.3. Inby/Outby 2-Wire Comm Connection.....	22
5.10.4. Inby/Outby 4-Wire Comm Connection.....	23
5.10.5. E1 Thru E7 Wires to Monitor PC Board 253-0334 .....	23
5.10.6. Control Output 0.....	23
5.10.7. Control Output 1.....	23
5.10.8. Digital Input 0 .....	24
5.10.9. Digital Input 1 .....	24
5.10.10. Analog Input 0.....	24
5.10.11. Analog Input 1.....	24
6. Calibration.....	26
6.0. General.....	26
6.1. Zero Calibration .....	26
6.2. Span Calibration.....	27
7. Testing .....	28
7.0. General.....	28
7.1. Perform Test.....	28
8. Installation Check List .....	29
9. Replacement Parts .....	30

## LIST OF FIGURES

TITLE	PAGE
Figure 1, Connection and Configuration Diagram.....	8
Figure 2, MC-4210-H2S Monitor Connections .....	16
Figure 3, Stand Alone Voltage Mode Connection to MC-4000 System.....	17
Figure 4, Stand Alone Current Loop Mode Connection to MC-4000 .....	18
Figure 5, MC-4210 (2 Wire Addressable Sensor) .....	21
Figure 6, MC-4210 (4 Wire Addressable Sensor) .....	21
Figure 7, Input/Output Interface PC Board Connections .....	25

# **1. INTRODUCTION**

## **1.0. General**

The American Mine Research MC-4210-H2S Addressable Sensor is a compact monitor designed to be used with our MC-4000 System. Available in a variety of gases, it has the traditional AMR quality construction, leading edge technology and maintenance free characteristics.

## **1.1. Features**

The features of the MC-4210-H2S monitor are summarized below:

- Available also as CO, NO, NO2, O2, SO2, H2 sensor (see separate manual)
- Stand Alone Voltage or Current Mode Operation
- May be used in permissible areas with like type classification barriers
- Low current operation: Less than 3 ma. in voltage mode
- High speed data rate: Normal 4800 baud, Fast 38.4K baud
- 4 Digit LCD Display
- Span calibration value down loaded from master station
- Magnetically activated test and calibration switch (can be calibrated without removing the cover)
- Microprocessor controlled calibration (no potentiometers to adjust)
- Smart operation: testing and calibration does not set off outside alarms.
- Alarm and Warning outputs adjustable
- Valid communications with Master Station indication
- Sealed polycarbonate enclosure
- Uses City Technology sensor cells
- Optional Input/Output Interface PC Board available

## 1.2. Default Values

The unit is shipped from the factory with the following default settings:

- Output mode: Voltage
- Full-scale value: 200PPM
- Calibration gas : 100PPM
- Test value: 200PPM
- Warning level: 40PPM
- Alarm level: 60 PPM

## 1.3. New Features

The American Mine Research MC-4210-H2S Sensor has all the features of the earlier MC-4110 model and many more. Listed below are the new features of the MC-4210-H2S sensor.

- One PC board for both sensor and communications instead of two
- Three rotary BCD switches for address instead of DIP switch
- Addressable to 256 instead of 128
- Four digit LCD display allows better resolution and range.
- Communication fuses mounted on the PC board
- Configuration switches instead of solder jumpers
- Sensor cell ZERO calibration error and SPAN calibration error indication
  
- Can serve as a small inexpensive remote with the following input/outputs:
  - ◆ Two current sink type control outputs
  - ◆ Two 0 to 3 VDC status inputs
  - ◆ Two 0 to 3 VDC analog inputs
  
- With optional Input/Output Interface PC Board it may be configured as a small remote with the following inputs/outputs:
  - ◆ Two 115 VAC at 3 amps or 28VDC at 3 amps control outputs
  - ◆ Two 115 VAC or 28 VDC status inputs
  - ◆ Two 0 to 3 VDC analog inputs

**NOTE: Use of the optional Input/Output PC Board will void the MSHA classification for use as a sensor.**

## 2. SPECIFICATIONS

- Size: 7"W x 7"H x 5"D
- Operating Voltage: +10VDC to +28VDC
- Operating Mode: Voltage Mode or Current (4-20mA) Mode
- Operating Current: Voltage Mode = 3.0mA.
- Operating Current: Addressable Sensor = 5.5mA
- Voltage Mode Output: 0.1 volts for 0 ppm
- Voltage Mode Output: 3.0 volts for 200 ppm
- Calibration Gas: Master Station Download (any value)
- Display: Four Digit LCD
- Detection Principle: Diffusion Type Electro-chemical
- Trip Outputs: Open Collector Current sink 100mA
- Warn, Alarm Trip Level: User Adjustable
- Zero Offset Level: User Adjustable (Provided for some users)
- Communication Interface: 2 Wire or 4 Wire RS-485
- Communication Baud Rate: 4800 or 38,400 baud

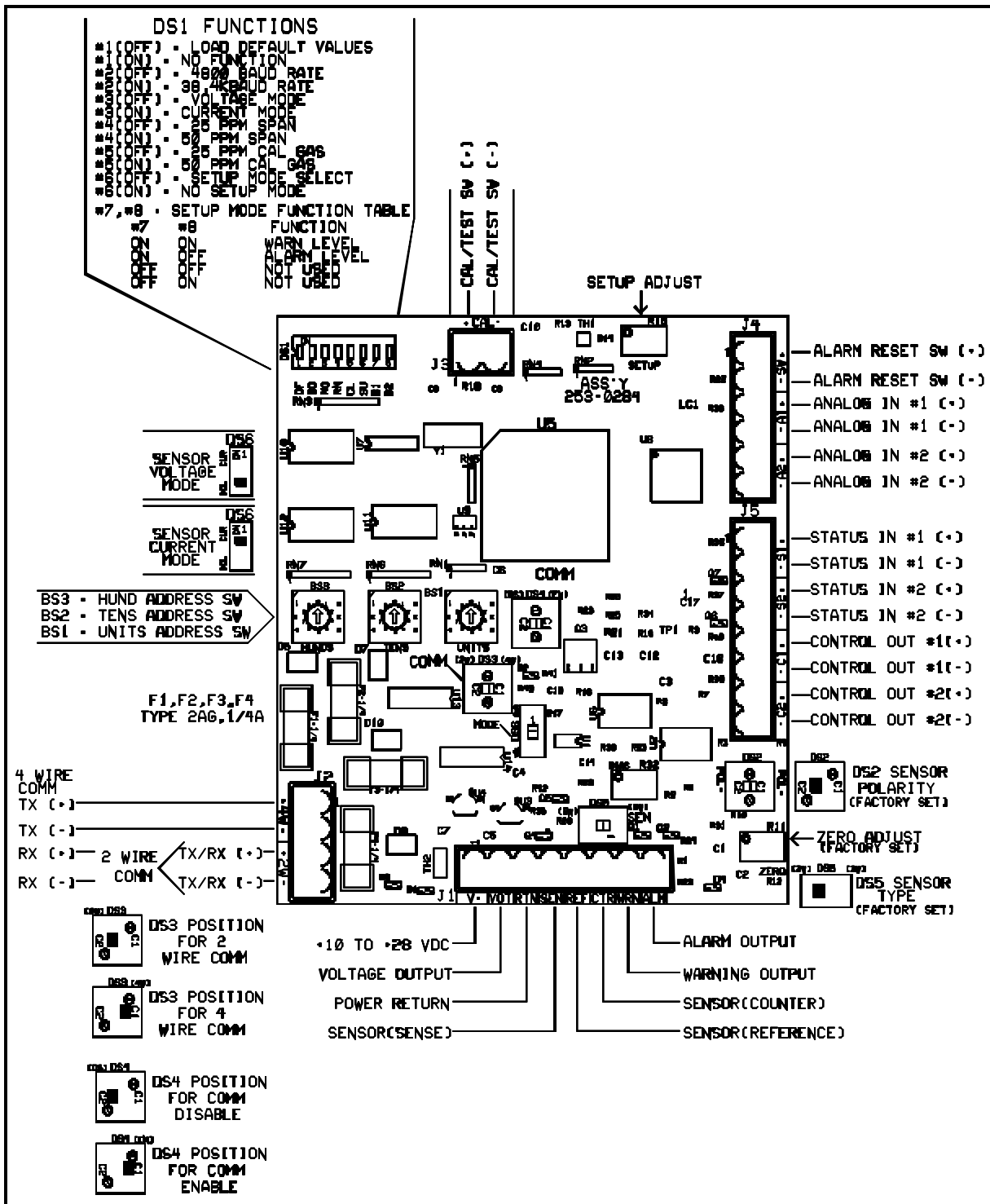

FIGURE 1, CONNECTION AND CONFIGURATION DIAGRAM  
H2S SENSOR PC BOARD ASSEMBLY 253-0334



### 3. SETUP

**NOTE: The MC-4210-H2S Addressable Sensor must have have PC Board Ass'y 253-0334 installed.**

#### 3.1. DS1 Setup Switch

The MC-4210-CO's setup is determined by an internal 8 position dip switch (DS1) as shown if Figure 1. The function of each position of the dip switch is described below:

DS1 FUNCTIONS		
SW#	POSITION	FUNCTION
1	OFF	NO FUNCTION
1	ON	LOAD DEFAULT VALUE
2	OFF	4800 BAUD RATE
2	ON	38.4K BAUD RATE
3	OFF	SENSOR VOLTAGE MODE
3	ON	SENSOR CURRENT MODE
4	OFF	NOT USED
4	ON	NOT USED
5	OFF	NOT USED
5	ON	NOT USED
6	OFF	SELECT SETUP MODE
6	ON	SETUP MODE OFF
7 AND 8 = SETUP MODE TRUTH TABLE BELOW		
#7	#8	FUNCTION
ON	ON	SET WARN LEVEL
OFF	ON	SET ALARM LEVEL
ON	OFF	NOT USED NOW
OFF	OFF	NOT USED NOW

Switch DS1 is a multipurpose configuration and setup switch. Each switch of DDS is described below:

(DS1-1) When placed to ON and power is then applied to the unit, the default calibration gas and the warning and alarm trip levels are loaded into memory.

**Note: After power has been applied, the DS1-1 switch must be placed to OFF. The load default values function is for use only as a stand-alone voltage or current mode sensor. When used as an addressable sensor, the load default values should not be used. Use the Master download function instead to change the span calibration gas level.**

### 3.1. DS1 Setup Switch (Cont.)

(DS1-2) Selects the MC-4000 Monitor System baud rate. OFF = 4800, ON=38.4K.

(DS1-3) Selects sensor output mode. OFF= voltage , ON= current.

**Note:** 1) The voltage mode should be used if the sensor is an addressable type.

2) Voltage mode output of 0.1 volts represents 0 PPM and 3.0 volts represents 200 PPM full scale.

3) Current mode output of 4 mA represents 0 PPM and 20 mA represents 200 PPM.

4) Place DS6 to agree with the mode switch

(DS1-4) NOT USED

(DS1-5) NOT USED

(DS1-6) Enables the sensor setup mode to allow setting the warn and alarm levels using the setup potentiometer (R15).

OFF= SETUP MODE ENABLED, ON= SETUP MODE OFF.

(DS1-7,8) These two switches are used according to the truth table above to select the warn or alarm value that is to be set using the SETUP potentiometer (R15). To set one of these values, place DS1-6 switch to the OFF position. The display will now read the current value given by the Setup Adjust potentiometer(Figure1). The value indicated will be the previously used position of the Setup Adjust potentiometer, not necessarily the value of the currently selected parameter. Next, configure switches DS1-7,8 according to the above table. Using a small screwdriver, adjust potentiometer R15 until the desired value is displayed. Now briefly activate the test/calibrate switch. The display will blink the setup value three times indicating that the displayed value has been saved. You may now select another parameter to set using the same procedure. Once all the values have been set, return the DS1-6 switch position to ON.

### 3.2. DS2 Cell Polarity

DS2 is for **FACTORY USE ONLY**. It is used to match the sensor cell polarity for each gas in the MC-4210 services.

### 3.3. DS3 2 Wire/4 Wire Comm

DS3 allows the MC-4210 to operate with either a 2 wire monitor system interface such as the MC-4000 system or a 4 wire monitor system. Push the switch to 2W to select 2 wire. Push the switch to 4W to select 4 wire.

### **3.4. DS4 Comm Enable/Disable**

DS4 will enable or disable the MC-4000 communication transceiver devices. Disabling these devices will reduce current consumption when the monitor is used in a **STAND ALONE** voltage mode or current mode application. Push the switch to DS to disable communication. Push the switch to EN to enable communication.

### **3.5. DS5 2 Wire/3 Wire Cell**

DS5 is for FACTORY USE ONLY. It is used to match the sensor cell type (2 wire or 3 wire) for each gas in the MC-4210 services.

### **3.6. DS6 Sensor Mode**

Switch DS6 is used to select the sensor output mode. VOL = voltage, CUR = current. **Note:** Place DS1-3 to proper position also.

### **3.7. Address Switches**

Rotary BCD switches BS3, BS2 and BS1 set the monitor address for the MC-4000 System. Valid monitor address are between 1 and 255.

### **3.8. Setup Adjust**

Setup Adjust (R15) is used in conjunction with the DS1 Setup Mode switches to adjust the warning and alarm trip levels and the zero offset value.

### **3.9. Zero Adjust**

Zero adjust (R11) is FACTORY SET ONLY. It is used to match the different sensor cells to the MC-4210 electronics.

**Note: This should not be user adjusted unless a calibration error “E” is displayed in the left digit of the LCD display during ZERO calibration of the sensor. See ZERO calibration in the calibration section 6.1. of this manual.**

### **3.10. Reference Adjust**

Reference Adjust (R32) is FACTORY SET ONLY. It is used in to match the different types of sensor cells to the MC-4210 electronics. **Note: This should not be user adjusted.**

### **3.11. Comm Fuses**

Fuses F1 thru F4 are RS-485 data line protection fuses that protect the communications circuitry from voltage transients on the communications line. Insure that these fuses are in place and are not open when sensor communications problems occur.

## 4. CONFIGURATION

**NOTE: The MC-4210-H2S Addressable Sensor must have have PC Board Ass'y 253-0334 installed.**

### 4.0. General

Refer to Figure 1, Connection and Configuration Diagram for MC-4210-H2S Sensor. The MC-4210 monitor may be configured for a variety of uses. It may be used as a stand alone gas sensor in either the voltage mode or 4 to 20 milliampere current loop mode. It may also be used with the American Mine Research MC-4000 Monitor System and serve as remote gas sensor. It may also serve as a small remote for monitor and control applications. Configuration involves setting various switches to allow the MC-4210-HW2 monitor to perform the different functions.

### 4.1. Current Loop Mode Sensor (Stand Alone)

To use the MC-4210 monitor in the current loop mode connect the monitor as described in the INSTALLATION section 5.1.2. and set the configuration switches as follows:

SWITCH	FUNCTION	POSITION
DS4	COMM ENAB/DISAB	DISABLE
DS6	MODE SELECT	CURRENT
DS1-3	MODE SELECT	ON

**Note:** The MC-4210 may not be used with the MC-4000 Monitor System when the MC-4210 is used in the current loop mode.

### 4.2. Voltage Mode Sensor (Stand Alone)

To use the MC-4210 monitor in the stand alone voltage mode connect the monitor as described in the INSTALLATION section 5.1.1. and set the configuration switches as follows:

SWITCH	FUNCTION	POSITION
DS4	COMM ENAB/DISAB	DISABLE
DS6	MODE SELECT	VOLTAGE
DS1-3	MODE SELECT	OFF

### 4.3. MC-4000 Monitor System Sensor/Remote

To use the MC-4210 monitor with the MC-4000 system as a gas sensor or as a combination sensor/small remote, connect the monitor as described in the INSTALLATION sections 5.1.1. thru 5.10.11.. Set these switches as follows:

SWITCH	FUNCTION	POSITION
DS4	COMM ENAB/DISAB	ENABLE
DS6	MODE SELECT	VOLTAGE
DS1-3	MODE SELECT	OFF

Set DS1-2 to select the desired baud rate (OFF for 4800, ON for 38.4k baud).

Set BS3, BS2, and BS1 to the desired monitor address for the MC-4000 System.

Set DS3 to select 2 wire communication interface.

Insure that fuses F1 thru F4 are in place and are functional.

## 5. INSTALLATION

### 5.0. General

**NOTE: The MC-4210-H2S Addressable Sensor must have have PC Board Ass'y 253-0334 installed.**

any The MC-4210-H2S may be installed in a variety of configurations to solve almost gas sensor requirements. The monitor may be used in a **Stand Alone** 4 to 20 milliamperere current loop output mode or a **Stand Alone** 0 to 3 VDC voltage output mode. When used in the voltage output mode, the monitor may also be connected to the American Mine Research MC-4000 System Master Station via a 2 wire or a 4 wire RS-485 hardware interface.

wire The monitor uses City Technology sensor cells and will accept both 2 wire and 3 type cells. The hydrogen sulfide sensor is a 3 wire sensor cell.

more The monitor may also be used as a monitor system small remote. In addition to the 100 milliamperere current sink type Warn and Alarm outputs, the monitor has two 100 milliamperere current sink type outputs triggered by the two digital status inputs. The two digital status inputs accept 0 to 5 VDC and trigger the control outputs at 2.5 VDC. The digital status information is sent to the MC-4000 System Master Station. The monitor will also accept two analog voltage inputs and send this information to the MC-4000 System Master Station. The analog voltage range is 0 to 3 VDC.

The monitor may also serve as a small remote by configuring it with an optional Input/Output Interface PC Board that will allow monitor and control of the following devices:

- control 2 each 115 VAC or 28 VDC at 3 amperes circuits
- monitor 2 each 115 VAC or 28 VDC circuits
- monitor 2 each 0 to 3 VDC or (4 to 20 mA current loops) analog inputs

## 5.1. Power Connections

The MC-4210-H2S monitor may be installed in a variety of configurations to accomplish different monitoring functions. Use Figure 1 and Figure 2 as reference for making connections in the following discussion of all the monitor applications.

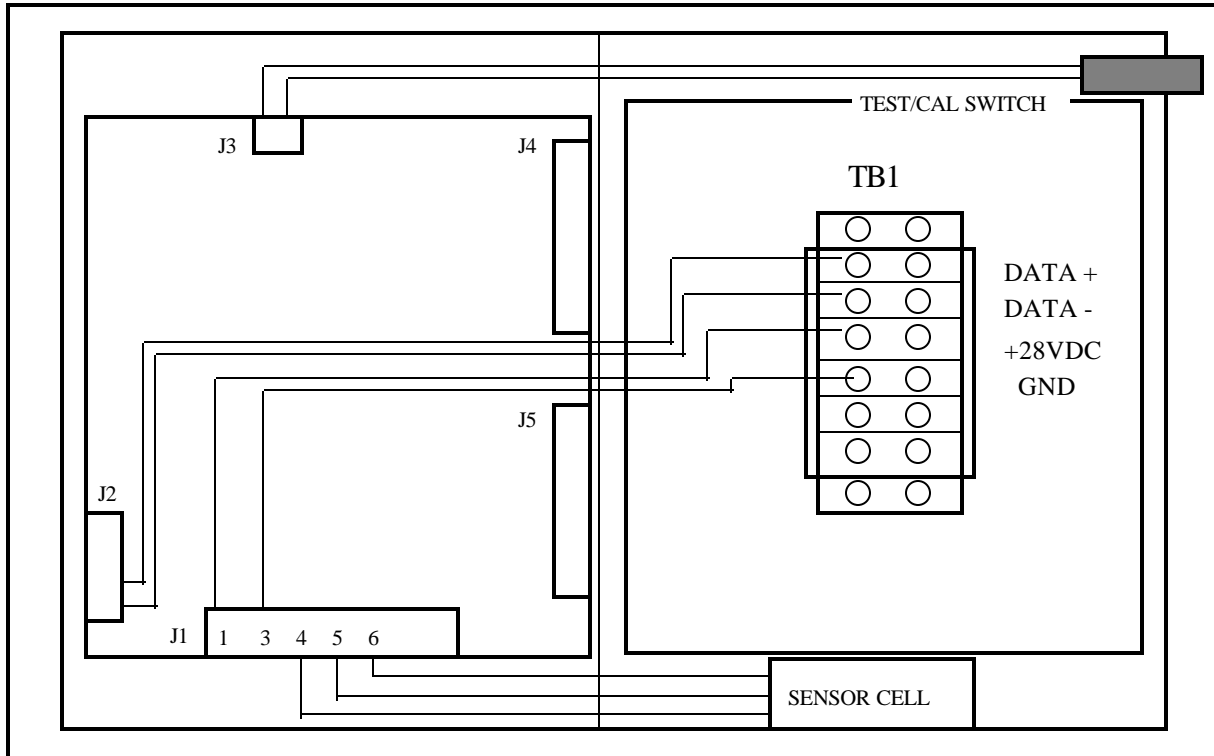

FIGURE 2, MC-4210-H2S MONITOR CONNECTIONS



### 5.1.1. Power Connection (Stand Alone Voltage Mode)

Refer to Figure 3. The sensor operates over the voltage range of 10 VDC to 28 VDC. Connect the (+) side of the voltage source to connector J1-1 (V+). Connect the (-) side of the voltage source to connector J1-3 (RTN). If the voltage output is used, connect it to J1-2 (VOT).

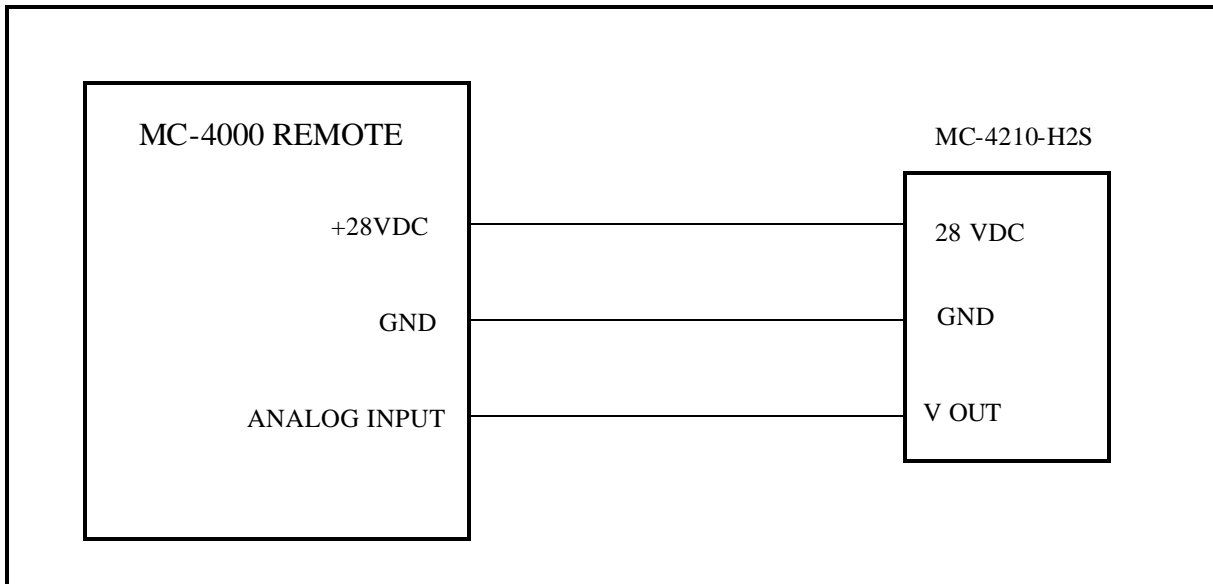

FIGURE 3, STAND ALONE VOLTAGE MODE CONNECTION TO MC-4000 MONITOR SYSTEM

### 5.1.2. Power Connection (Current Mode)

Refer to Figure 4. The sensor operates over the voltage range of 10 VDC to 28 VDC. Connect the (+) side of the voltage source to connector J1-1 (V+). Connect the top side of the current loop monitor resistor to J1-3 (RTN). Connect the bottom side of the current loop monitor resistor the (-) side of the voltage source. **Note:** VOT is not used in the current loop mode.

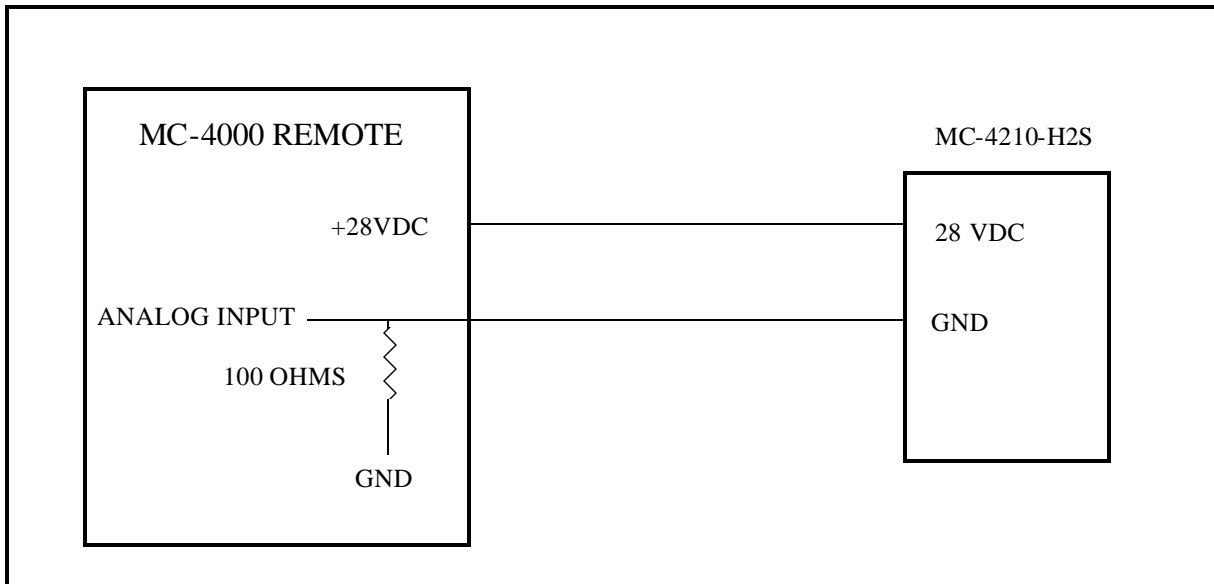

FIGURE 4, STAND ALONE CURRENT LOOP MODE CONNECTION TO MC-4000 MONITOR SYSTEM

## 5.2. Sensor Cell Connection

The MC-4210 monitor may be connected to either 2 wire or 3 wire City Technology sensor cells. The H2S sensor is a 3 wire sensor cell.

For 2 wire cells, connect the SENSE (white/black wire) to J1-4 (SEN) and connect the COUNTER (white/red wire) to J1-6 (CTR). **Note:** The REF is not used with the 2 wire sensor cell.

For 3 wire cells, connect the SENSE (white/black wire) to J1-4 (SEN). Connect the REFERENCE (white wire) to J1-5 (REF) and connect the COUNTER (white/red wire) to J1-6 (CTR).

## 5.3. Warn/Alarm Output Connection

The warning and alarm outputs are used to provide audible/visual outputs to indicate the monitor preset levels have been exceeded or they may be used to perform some control function (close door, start device) when these preset levels have been exceeded. Connect the (+) side of the device to be controlled to the (+) side of the power source (+ 28 VDC or less). Connect the (-) side of the device to be controlled to either J1-7(WRN) or J1-8 (ALM). Connect the RETURN of the power source to J1-3 (RTN) of the MC-4210. **Note:** The current requirement of the device to be controlled can not exceed 100 milliamperes.

## 5.4. Analog Input # 1 and Analog Input # 2 Connection

When the MC-4210-H2S monitor is used with the MC-4000 Monitor System, it may be connected to other sensors or transducers that provide a voltage output of 0 to +3 VDC or a 4 to 20 current mode output. The monitor will convert the analog input signal and send the value back to the MC-4000 Monitor System Master Station.

Analog input # 1 is connected between J4-3(+) and J4-4 (-). Analog # 2 is connected between J4-5 (+) and J4-6(-).

If the input is from a voltage mode sensor, connect the (+) voltage output and the (-) return to the connector as defined above.

If the input is from a current mode sensor, connect the current loop monitor resistor across the J4 (+) and (-) connections as defined above.

## **5.5. Status Input # 1 and Status Input # 2 Connection**

The MC-4210 may be used to monitor digital (ON/OFF) status signals to perform output control functions (start/stop pump as a function of water level). When the MC-4210 monitor is used with the MC-4000 Monitor System, it may be used as a small remote to monitor and control digital (ON/OFF) signals. The status input voltage must be in the range of 0 to 5 VDC. Status input #1 is connected between J5-1(+) and J5-2 (-). Status input #2 is connected between J5-3 (+) and J5-4 (-).

## **5.6. Control Output # 1 and Control Output # 2 Connection**

The MC-4210 the monitor has two 100 milliampere current sink type outputs that are triggered by the two digital status inputs. These outputs may be used in conjunction with an interface relay to perform heavy duty control applications (start/stop pump as a function of water level). Connect the (+) side of the device to be controlled to the (+) side of the power source (+28 VDC or less). Connect the (-) side of the device to be controlled to either J5-5 (#1 output) or J5-7 (# 2 output). Connect the RETURN of the power source to either J5-6 (#1 output) or J5-8 (# 2 output).

## **5.7. Calibration/Test Switch Connection**

Connect the magnetically activated reed switch used for calibrating and testing the MC-4210 to connector J3.

## **5.8. 2-Wire MC-4000 Monitor System Connection**

If the MC-4210 is used either as a gas sensor or as a small remote with the American Mine Research MC-4000 Monitor System it must be connected to the RS-485 communication data line using the 2 wire connection scheme as shown in Figure 2. Connect the data (+) (TB1-1) wire to J2-3 and data (-) (TB1-2) wire to J2-4.

## **5.9. 4-Wire Monitor System Connection**

the If the MC-4210 is used either as a gas sensor or as a small remote with a 4 wire monitor system it must be connected to the RS-485 communication data line using the 4 wire connection scheme shown in Figure 3. Connect the Master Station TX(+) (TB1-1) wire to J2-1 and TX(-)(TB1-2) wire to J2-2. Connect the Master Station RX(+) wire to J2-3 and RX(-) wire to J2-4. Connect +28VDC (TB1-5) to J1-1 and GND (TB1-6) to J1-3.

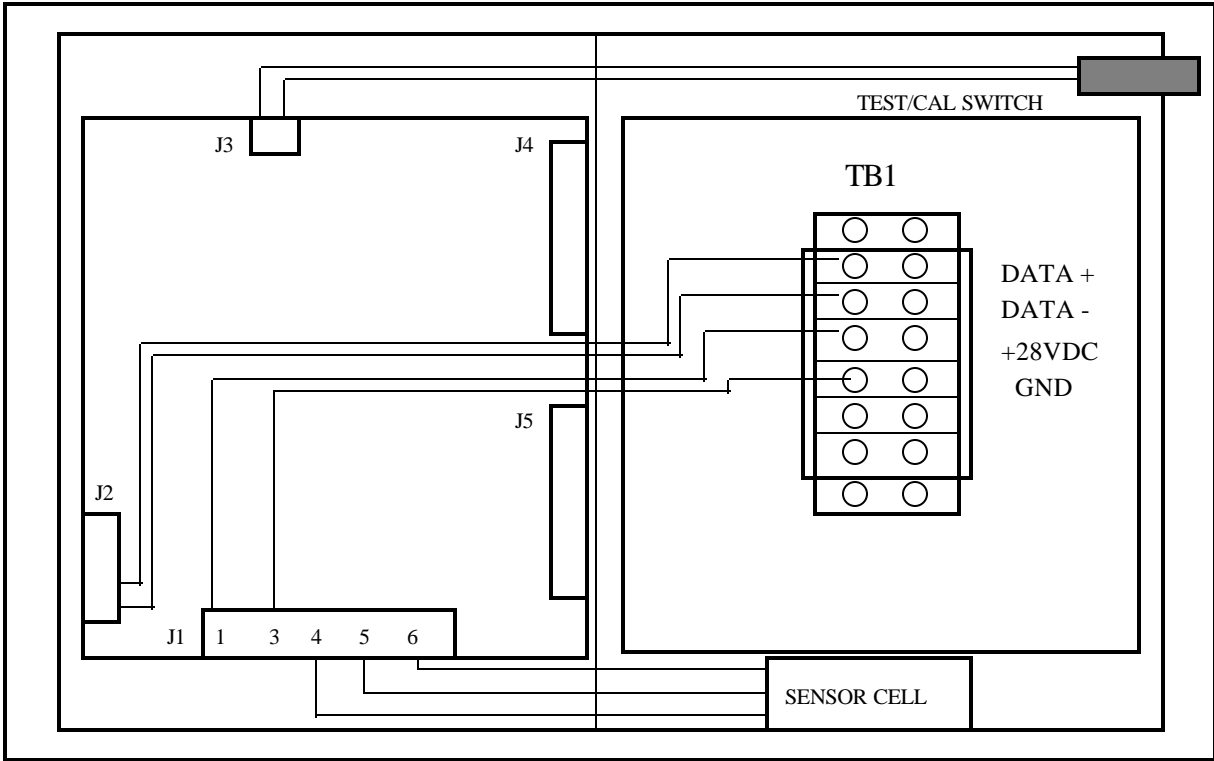

FIGURE 5, MC-4210 (2 WIRE ADDRESSABLE SENSOR)

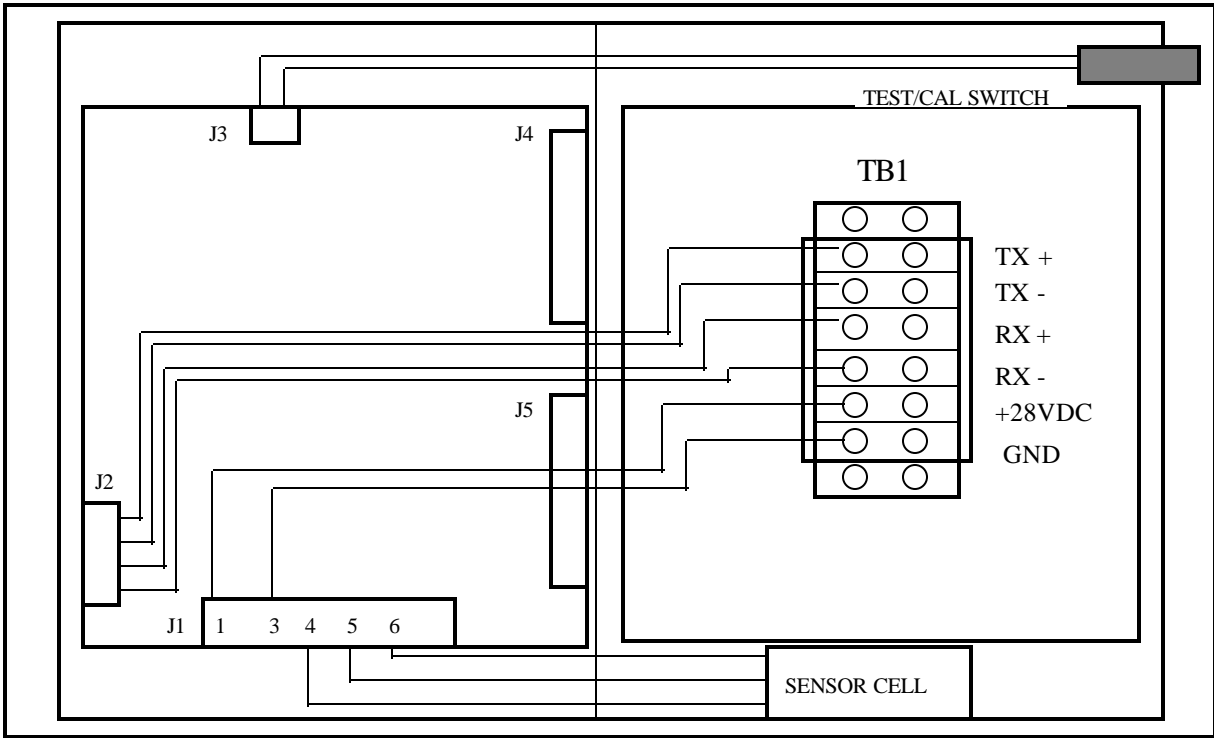

FIGURE 6, MC-4210 (4 WIRE ADDRESSABLE SENSOR)

## **5. 10. Input/Output Interface PC Board**

The MC-4210-H2S monitor may also serve as a small remote by configuring it with an optional Input/Output Interface PC Board that will allow monitor and control of the following devices:

- 1) control 2 each 115 VAC or 28 VDC at 3 amperes circuits
- 2) monitor 2 each 115 VAC or 28 VDC circuits
- 3) monitor 2 each 0 to 3 VDC or (4 to 20 mA current loops) analog inputs

### **5.10.1. Remove MC-4210-H2S Terminal Block Board**

The Input/Output Interface PC Board fits the same mounting holes as the terminal block board installed in the bottom of the MC-4210-H2S monitor. Remove power from the monitor and disconnect all wires from the terminal block board. Remove the terminal block board and replace it with the Input/Output Interface PC Board.

### **5.10.2. Inby/Outby Power Connection**

Refer to Figure 7 and connect the wires that provide +28 VDC and Ground to power to inby monitors and remotes to TB3 positions 5 and 6 respectively. Connect the wires from outby the monitor that provide +28 VDC and Ground to power the monitor to TB2 positions 5 and 6 respectively.

### **5.10.3. Inby/Outby 2 - Wire Comm Connection**

Refer to Figure 7. For the 2 - wire MC-4000 Monitor System communication line, connect the inby comm (+) and comm (-) to TB3 positions 3 and 4 respectively. Connect the wires from outby the monitor that provide comm (+) and comm (-) to the monitor to TB2 positions 3 and 4 respectively.

#### **5.10.4. Inby/Outby 4 - Wire Comm Connection**

Refer to Figure 7. For the 4 - wire monitor system communication line, connect the inby comm (+) and comm (-) to TB3 positions 1 and 2 respectively. Connect the wires from outby the monitor that provide comm (+) and comm (-) to the monitor to TB2 positions 1 and 2 respectively.

#### **5.10.5. E1 - E7 Wires to Monitor PC Board 253-0334**

Refer to Figure 7. Connect wires E1 thru E7 to the monitor pc board assembly 253-0334 as follows:

- E1 to J5-5 Control Output 0
- E2 to J5-7 Control Output 1
- E3 to J5-1 Digital Input 0
- E4 to J5-3 Digital Input 1
- E5 to J4-3 Analog Input 0
- E6 to J4-5 Analog Input 1
- E7 to J4-6 Ground

#### **5.10.6. Control Output 0**

Refer to Figure 7. The load that is to be controlled by output 0 may be powered either by 115 VAC or 28 VDC. The load current must be less than 3 amperes. The control device is an isolated bi-directional solid state switch so polarity is not important. Connect the device to be controlled to TB1 positions 1 and 2.

#### **5.10.7. Control Output 1**

Refer to Figure 7. The load that is to be controlled by output 1 may be powered either by 115 VAC or 28 VDC. The load current must be less than 3 amperes. The control device is an isolated bi-directional solid state switch so polarity is not important. Connect the device to be controlled to TB1 positions 3 and 4.

### **5.10.8. Digital Input 0**

Refer to Figure 7. Digital Input 0 is typically connected across a contact that is controlling a 115 VAC device or 28 VDC device. A bi-directional input opto-coupler is used on the interface pc board to monitor the presence of voltage. Polarity is not important. Connect the device or contact to be monitored to TB1 positions 5 and 6.

### **5.10.9. Digital Input 1**

Refer to Figure 7. Digital Input 1 is typically connected across a contact that is controlling a 115 VAC device or 28 VDC device. A bi-directional input opto-coupler is used on the interface pc board to monitor the presence of voltage. Polarity is not important. Connect the device or contact to be monitored to TB1 positions 7 and 8.

### **5.10.10. Analog Input 0**

Refer to Figure 7. Analog input 0 may be either from a 0 to 3 VDC voltage source or a 4 to 20 mA current loop source. If the analog input is from a voltage source, remove the 100 ohm termination resistor R3. If the analog input is from a current source, insure that the 100 ohm termination resistor R3 is installed. Connect analog input 0 (+) to TB1-9 and analog input 0 (-) to TB1-10. The analog input signal device may be powered from the same +28 VDC that powers the MC-4210-H2S monitor.

### **5.10.11. Analog Input 1**

Refer to Figure 7. Analog input 1 may be either from a 0 to 3 VDC voltage source or a 4 to 20 mA current loop source. If the analog input is from a voltage source, remove the 100 ohm termination resistor R4. If the analog input is from a current source, insure that the 100 ohm termination resistor R4 is installed. Connect analog input 0 (+) to TB1-11 and analog input 0 (-) to TB1-12. The analog input signal device may be powered from the same +28 VDC that powers the MC-4210-H2S monitor.



NOTES:

- 1) CONTROL OUTPUTS ARE LIMITED TO 3 AMPERES
- 2) CONTROL OUTPUTS ARE NON-POLAR
- 3) DIGITAL INPUTS ARE NON-POLAR
- 4) ANALOG INPUTS ARE 0 TO 3 VDC
- 5) USE 10K OHM RESISTORS FOR R3 AND R4 IF ANALOG INPUT ARE CURRENT MODE

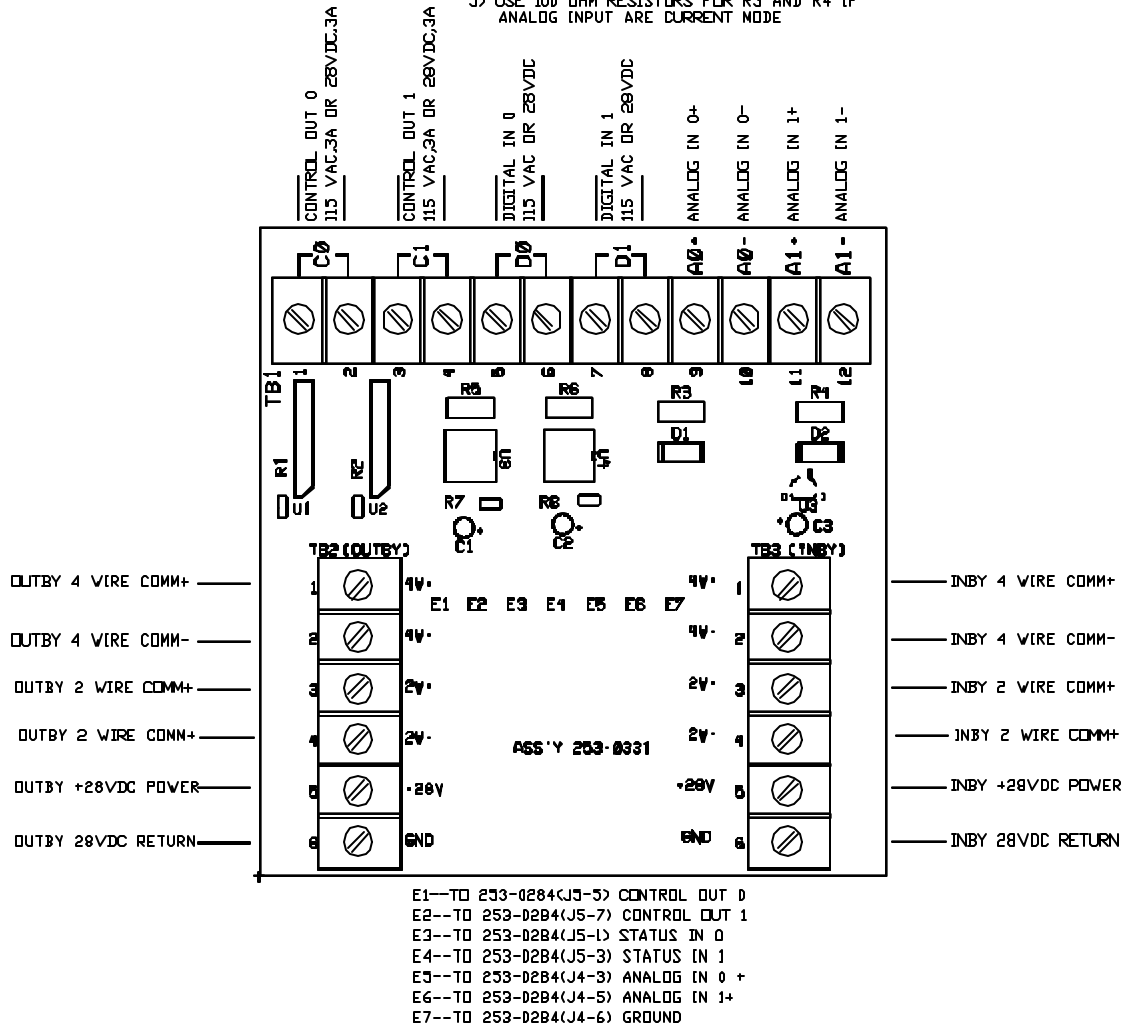

**NOTE: The MC-4210-H2S Addressable Sensor must have have PC Board Ass'y 253-0334 installed.**

FIGURE 7, INPUT/OUTPUT INTERFACE PC BOARD CONNECTIONS

## 6. CALIBRATION

### 6.0. General

**NOTE: The MC-4210-H2S Addressable Sensor must have have PC Board Ass'y 253-0334 installed.**

Calibration of the monitor is required by law to be performed every 30 days to allow the monitor electronics to compensate for any aging of the sensor cell. The process consists of applying **ZERO** and **SPAN** gases to the sensor cell and holding a magnet to the TEST/CALIBRATE magnetic switch to allow the electronics to save the two values.

### 6.1. Zero Calibration

- 1) Apply a ZERO gas to the sensor cell input and wait 2 minutes for the cell to stabilize.
- 2) Hold a magnet to the magnetically activated CAL/TEST switch
- 3) Observe the LCD display and verify the value jumps to 2 or 3 PPM and then slowly decreases to ZERO. When the display reaches ZERO, also observe that the display now blinks ZERO. This indicates the ZERO parameters for the sensor cell have been saved in memory. It also starts a timer that gives the operator 3 minutes to properly perform the SPAN calibration.
- 4) Remove the magnet from the CAL/TEST switch.
- 5) During ZERO calibration of the sensor electronics, the unit evaluates the amplified gas sensor cell output and the sensor electronics ZERO adjust to determine that the amplified cell output value is between 0.10 VDC and 0.50 VDC at the test point TP1. If the voltage is not between these two values a **sensor calibration error "E"** will appear in the left digit of the LCD display as the LCD begins to flash "**E00**". The "**E**" error indication will remain **ON** until the ZERO is adjusted and the sensor is re-calibrated. The MC-4000 Master Station will also be notified that a calibration error has occurred at this sensor. Should the "**E**" error indication occur, open the sensor enclosure door and connect a VOM between TP1 and POWER RETURN (J1-3). Adjust the ZERO ADJUST potentiometer until the VOM indicates 0.30 VDC. Perform the ZERO calibration again.
- 6) Remove the ZERO gas from the sensor cell and prepare to perform the SPAN calibration.

## 6.2. Span Calibration

- 1) Apply a SPAN gas to the sensor cell input and wait 2 minutes for the cell to stabilize. Observe that the LCD display value increases and stabilizes.
- 2) Hold a magnet to the magnetically activated CAL/TEST switch.
- 3) Observe the LCD display and verify the value jumps 2 or 3 PPM below the desired SPAN calibration value then slowly increases to the SPAN calibration gas value. When the display reaches the SPAN value also observe that the display now blinks the SPAN value. This indicates the SPAN parameters for the sensor cell have been saved in memory.
- 4) Remove the magnet from the CAL/TEST switch.
- 5) During SPAN calibration of the sensor electronics, the unit evaluates the amplified gas sensor cell output to determine that the value is between 1.50 VDC and 3.00VDC at the test point TP1. If the voltage is not between these two values a **sensor calibration error “E”** will appear in the left digit of the LCD display as the LCD begins to flash the full scale value. The “E” error indicates that the sensor cell is defective and should be replaced. The “E” will remain **ON** until the sensor cell is replaced and re-calibrated properly. The MC-4000 Master Station will also be notified that a calibration error has occurred at this sensor.  
**Note: There is no adjustment available to bring the amplified sensor cell output back into the proper range. Replace the sensor cell or the entire unit.**
- 6) Remove the SPAN gas from the sensor cell and observe that the LCD display returns to zero or to the ambient value.

## **7. TESTING**

### **7.0. General**

**NOTE: The MC-4210-H2S Addressable Sensor must have have PC Board Ass'y 253-0334 installed.**

The TEST operation displays certain calibration and setup values along with the address of the monitor (when used with the MC-4000 system). During TEST, the WARN and ALARM outputs will be activated and the MC-4000 Master Station will be alerted that the monitor is performing a TEST so the Master Station generated alarms may be prohibited.

### **7.1. Perform Test**

- 1) Quickly tap the CAL/TEST switch with a magnet. Observe the display reading.
- 2) The LCD display will show the following values in the order below:
  - a. Monitor Electronics Test (value slowly rises to 50 PPM)
  - b. SPAN calibration value
  - c. WARN trip level
  - d. ALARM trip level
  - e. ADDRESS for use with the MC-4000 monitor system

#### **Notes:**

- 1) The SPAN calibration may be changed by performing a MC-4000 monitor system download operation.
- 2) The WARN and ALARM trip levels may be changed using the SETUP procedures( See Operation section using DS1 for SETUP operation).
- 3) If there is valid communications with the MC-4000 Monitor System Master Station, the ADDRESS number will blink. If there is no communications with the Master Station, the ADDRESS number will be displayed but will not blink.

## 8. INSTALLATION CHECK LIST

**NOTE: The MC-4210-H2S Addressable Sensor must have have PC Board Ass'y 253-0334 installed.**

Use the Setup, Configuration, and Installation sections as an aid to place the appropriate switches in the correct positions for the desired monitor function (stand alone current loop output, stand alone voltage output or MC-4000 system monitor).

- ◇ If the monitor function is current loop mode sensor perform the following:
  - ◇ Switch DS4 to Comm Disable (Section 4.1., page 13)
  - ◇ Switch DS6 to Current Mode (Section 4.1., page 13)
  - ◇ Switch DS1-3 to ON (Section 4.1., page 13)
  - ◇ Connect Power (Section 5.1.2., page 18)
- ◇ If the monitor function voltage mode sensor perform the following:
  - ◇ Switch DS4 to Comm Disable (Section 4.2., page 13)
  - ◇ Switch DS6 to Voltage Mode (Section 4.2., page 13)
  - ◇ Switch DS1-3 to OFF (Section 4.2., page 13)
  - ◇ Connect Power (Section 5.1.1., page 17 )
- ◇ If the monitor function is a MC-4000 system monitor perform the following:
  - ◇ Switch DS4 to Comm Enable (Section 4.3., page 14)
  - ◇ Switch DS6 to Voltage Mode (Section 4.3., page 14)
  - ◇ Switch DS1-3 to OFF (Section 4.3., page 14)
  - ◇ Set DS1-2 for desired Baud Rate (Section 3.1., page 10)
  - ◇ Set Address Switches (Section 3.7., page 11)
  - ◇ Wire for 2 wire or 4 wire communications Section 5.8. or 5.9., page 20)
  - ◇ Connect Power (Section 5.1.1., page 16)
- ◇ Calibrate the monitor if required using Section 6.
- ◇ Test the monitor if required using Section 7.

## 9. REPLACEMENT PARTS

<b>Part Number</b>	<b>Description</b>
253-0334	Sensor Board
270-0172	H2S Sensor Cell Assembly
125-0160	Enclosure (MC-4210)
066-0009	LCD Display
270-0111	Test/Calibration Switch
150-0140	6 Position Terminal Block(Back Plate)
160-0036	Fuse for F1 - F4
253-0331	Input/Output Interface PC Board